

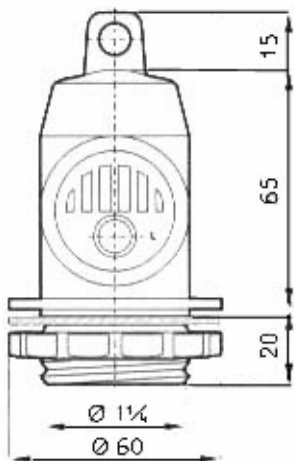

**APAG** Via Jhon Wiston Lennon n°40 42018 San Martino in Rio (R.E.) Italy  
 tel:+39-0522-633065 Fax:+39-0522-732934 e-mail: [apag@apag.it](mailto:apag@apag.it) www.apag.it

## VALVOLE SFIATO PER SERBATOI - SOUPAPE POUR CUVE VÁLVULAS PARA DEPOSITO - VALVE FOR RESERVOIRS



**P/V/15:** VALVOLA SFIATO PER SERBATOIO FINO A 150 HL. DIAM. 15 ATTACCO 1 1/4"



**P/V/15:** SOUPAPE POUR CUVE JUSQU' A 150 HL D. 15 FILETAGE 33.42



**P/V/15:** VÁLVULAS PARA DEPOSITO HASTA 150 HL. D.15 ROSCA 1 1/4"



**P/V/15:** VENT VALVE FOR RESERVOIRS TILL 150 HL. D.15 1 1/4"



**P/V/30N:** VALVOLA SFIATO DOPPIO EFFETTO PER SERBATOIO FINO A 500 HL DIAM. 30 ATTACCO 1 1/4" - 1 1/2"



**P/V/30N:** SOUPAPE POUR CUVE DOUBLE EFFET JUSQUE A 500 HL. D. 30 FILETAGE 33/42 - 40/49



**P/V/30N:** VALVULAS A DOBLE EFECTO PARA DEPOSITO HASTA 500 HL. D.30 ROSCA 1 1/4" - 1 1/2"



**P/V/30N:** VENT VALVE DOUBLE EFFECT FOR RESERVOIRS TILL 500 HL. D.30 1 1/4" 1 1/2"

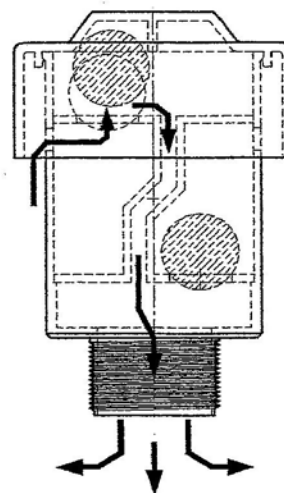
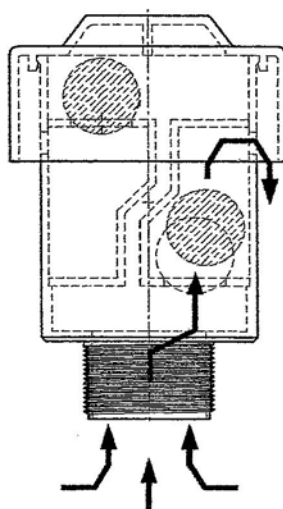
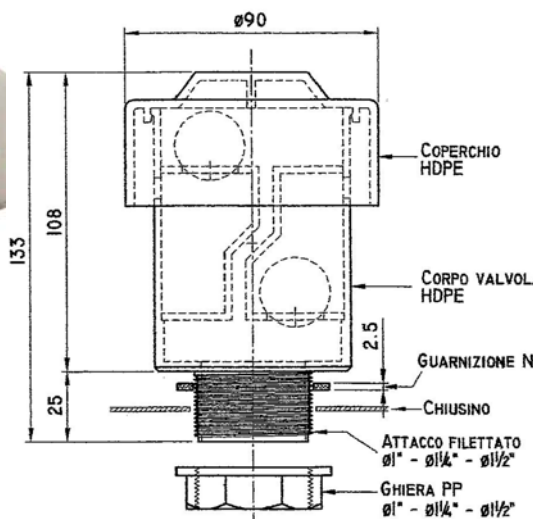

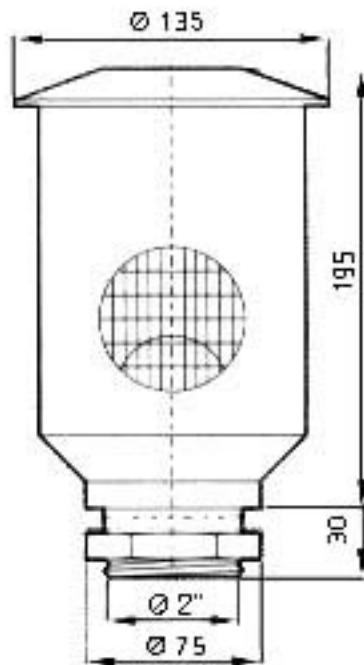
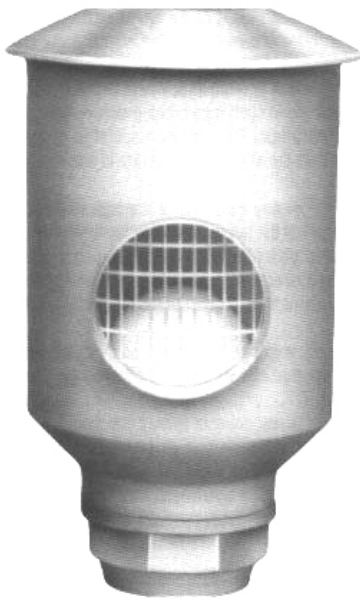



 **P/V/50:** VALVOLA SFIATO PER SERBATOIO FINO A 1.000 HL DIAM. 50 RACCORDI 2"

 **P/V/50:** SOUPAPE POUR CUVE JUSQU'A 1.000 HL.D.50 FILETAGE 50-60 2''M

 **P/V/50:** VALVULAS PARA DEPOSITO HASTA 1.000 HL D.50 ROSCA 2''M

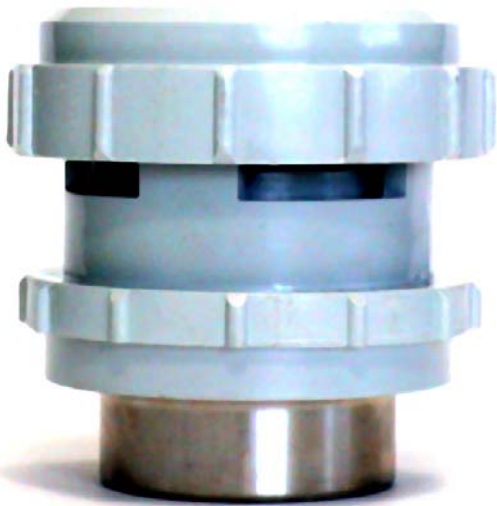
 **P/V/50:** VENT VALVES FOR RESERVOIRS HILL 1.000 HL D.50 CONNECTION 2''M



 **L/VSDN50 :** VALVOLA SFIATO DOPPIO EFFETTO PER SERBATOIO SENSIBILITÀ 0,002 BAR IN PRESSIONE 0,005 IN VUOTO PORTATA 100.000 L/H COMPLETA DI RACCORDO DN50 DIN 11.851

 **L/VSDN50 :** SOUPAPE POUR CUVE DOUBLE EFFET 0,002 BAR EN PRESSION 0,005 BAR EN VIDE CAPACITÉ 100.000 L/H AVEC RACCORD DN 50 DIN 11.851

 **L/VSDN50 :** VÁLVULAS PARA DEPOSITO A DOS EFECTO SENSIBILIDAD 0,002 BAR EN PRESIÓN Y 0,005 EN VACÍO CAPACIDAD 100.000 L/H CON ROSCA DN 50 DIN 11.851

 **L/VSDN50 :** VENT VALVE DOUBLE EFFECT FOR RESERVOIRS SENSIBILITY 0,002 BAR IN PRESSURE 0,005 BAR IN VACUUM CAPACITY 100.000 L/H WITH CONNECTION DN 50 DIN 11.851



 **F/VSDN50-80:** VALVOLA SFIATO DOPPIO EFFETTO PER SERBATOIO IN AISI 304- 316 PER SERBATOI DA 400-600HL RACCORDO DN 50-80 DIN 11.851

 **F/VSDN50-80:** SOUPAPE POUR CUVE DOUBLE EFFET EN ACIER INOX 304-316 POUR CUVE JUSQUE 400-600 HL FILETAGE DN.50-80 DIN 11.851

 **F/VSDN50-80:** VÁLVULAS PARA DEPOSITO A DOS EFECTO EN ACERO INOXIDABLE 304-316 PARA DEPOSITO DE 400-600HL ROSCA DN.50-80 DIN 11.851

 **F/VSDN50-80:** VENT VALVE DOUBLE EFFECT IN STAINLESS STEEL 304-316 FOR RESERVOIRS TILL 400-600HL CONNECTION DN.50-80 DIN 11.851